

motivation in these studies was to relate intrachain reactivity to the conformational and/or dynamic properties of the chain connecting the functional groups, thus providing a probe for the shape and flexibility of polymer chains in solution. While the matter is outside the scope of this Account, attention is called to recent studies by Sisido and his group<sup>43</sup> on the kinetics and equilibria of intramolecular interactions of end groups attached to polysarcosine and polyoxyethylene chains with a number of atoms up to about 50-100. The ease of ring closure was found to decrease but moderately as the chain length increased, the EM values for the cyclization of very long chains being in the order of  $1 \times 10^{-2}$  M or slightly less. Thus, only within chain lengths of about 10 atoms does a dramatic

(42) See, for example, (a) H. Morawetz, *Pure App. Chem.*, **38**, 267 (1974); (b) A. Perico and C. Cuniberti, *J. Polym. Sci.*, **15**, 1435 (1977); (c) M. Sisido and K. Shimada, *J. Am. Chem. Soc.*, **99**, 7785 (1977); (d) M. Sisido and K. Shimada, *Macromolecules*, **12**, 790, 792 (1979); (e) D. S. Saunders and M. A. Winnik, *ibid.*, **11**, 18, 25 (1978); (f) G. Wilemski and M. Fixman, *J. Chem. Phys.*, **60**, 866, 878 (1974).

(43) (a) M. Sisido, T. Mitamura, Y. Imanishi, and T. Higashimura, *Macromolecules*, **9**, 316 (1976); (b) M. Sisido, H. Takagi, Y. Imanishi, and T. Higashimura, *ibid.*, **10**, 125 (1977); (c) *Bull. Chem. Soc. Jpn.*, **50**, 1807 (1977); (d) M. Sisido, E. Yoshikawa, Y. Imanishi, and T. Higashimura, *ibid.*, **51**, 1464 (1978).

reactivity drop occur. Sisido's data indicate that the reactivity level we have determined for large rings up to about 30-membered decreases only slightly for chains whose length is as high as 100 members.

### Concluding Remarks

We have gained new insights into the factors controlling the formation of ring molecules by quantitative investigation of ring-closure reactions over a wide spectrum of ring sizes. The determination of effective molarities (EM) has stimulated accurate collateral analysis of intermolecular model reactions.

One of the most spectacular results of these studies is the observation that EM values tend to become similar to each other whatever the nature of the reaction, the structural series and the experimental conditions, as the ring size increases slightly beyond the medium ring region. The effect has been ascertained as far as ring size 32.

The data obtained and the principles revealed by this approach provide a general basis for the interpretation of ring closure reactivity. Among other applications, this basis will enable recognition and assist interpretation of unusual effects encountered in special cases.

## Synthetic Model Compounds for Hemoproteins

T. G. TRAYLOR

Department of Chemistry, D-006, University of California, San Diego, La Jolla, California 92093

Received April 2, 1980 (Revised Manuscript Received November 24, 1980)

Hemoproteins are biomolecules which employ iron porphyrins in their active sites. They accomplish dioxygen transport, electron transport, hydrogen peroxide destruction, oxygen reduction, and several kinds of oxidation including alkane hydroxylation.<sup>1,2</sup> Except for electron-transporting proteins, all of these molecules employ a five-coordinated iron in order to leave the sixth position open for ligand binding or catalytic activity. The dioxygen-transporting hemoproteins further require that the iron be maintained in the ferrous state.<sup>1</sup> This is not the thermodynamically stable state in the presence of dioxygen, and thus the protein somehow retards oxidation to the Fe<sup>III</sup> state.

We began our present work with the idea of removing the active site from these dioxygen-transporting proteins and studying the effects of structure and environment upon its reversible oxygenation. To do this we needed to obtain a "model compound" which would resemble the protein and resist oxidation long enough for measurements to be made. This can be accom-

plished by either slowing down oxidation or speeding up the measurements.

Following Wang's seminal discovery that a heme-imidazole mixture in a polymer matrix could be reversibly oxygenated,<sup>3</sup> we conceived the idea that a model compound should have one side protected with a hydrophobic structure and should have on the opposite side a covalently attached imidazole to maintain five-coordination,<sup>4</sup> the "chelated heme" approach. We reported the synthesis of a protected porphyrin, porphyrin cyclophane, in 1971, at which time we planned to combine the "protected heme" and "chelated heme" approach into a single molecule. However, alternative ways to observe reversible oxygenation were discovered,<sup>5-8</sup> and we temporarily abandoned the protected

(1) Antonini, F.; Brunori, M. "Hemoglobin and Myoglobin and Their Reactions with Ligands"; North-Holland Publishing Co.: Amsterdam, 1971: (a) p 50; (b) p 221; (c) p 93; (d) p 225; (e) p 227.

(2) Gunsalus, I. C.; Meek, J. R.; Lipscomb, J. D.; Debrunner, P.; Munck, E. "Mechanisms of Oxygen Activation"; Hayaishi, O., Ed.; Academic Press: New York, 1974; pp 559-613.

(3) Wang, J. H. In "Oxygenases"; Hayaishi, O., Ed.; Academic Press: New York, 1962; pp 502-511.

(4) (a) Diekmann, H.; Chang, C. K.; Traylor, T. G. *J. Am. Chem. Soc.* **1971**, **93**, 4068-4070. (b) This cyclophane was not tested for dioxygen binding. However, we have recently prepared an anthracene-7,7-heme cyclophane which forms a stable oxygen complex in solution, thus demonstrating the viability of the original cyclophane approach to heme protection (S. Tsuchiya, unpublished). See also ref 13b for another example.

Teddy Traylor was born in Sulphur, Oklahoma, in 1925. He received his B.A. and Ph.D. from the University of California, Los Angeles, with the late Saul Winstein. After 7 years with Dow Chemical Co. and 2 years as a post-doctoral fellow with Professor Paul D. Bartlett at Harvard University, he joined in 1961 the faculty of the University of California, San Diego, where he is a Professor of Chemistry. He was a Guggenheim Fellow in 1976. His current research interests include bioorganic and organometallic chemistry.

heme approach in favor of the much simpler chelated heme method. Others have developed the "protected heme" idea in very elegant ways, and there are now many such model compounds.<sup>9-13</sup>

The first solution oxygenation of a heme model compound, chelated pyrrheme, was reported in 1973,<sup>5</sup> simultaneous with the report of oxygenation of another iron macrocycle by Baldwin et al.,<sup>14</sup> both at low temperature. Several other examples of oxygenation of model compounds were soon reported,<sup>7-10</sup> and methods of observing reversible oxygenation developed rapidly. Quantitative studies of dioxygen binding to model compounds began to appear in 1975.<sup>15,16a</sup>

### Design of Model Compounds

A major objective in synthesizing model compounds for oxygen-transporting heme proteins is to accomplish reversible oxygenation (eq 1) without competing oxidation (eq 2). There are two rather different ap-

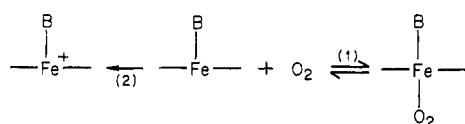

proaches to the design of such compounds which we might call static models and dynamic models. In the design of static models, the principal objective is to obtain a dioxygen complex which is stable under most conditions (room temperature, high concentrations, etc.) so that crystal structure studies, the older manometric methods of gas titration, and other slow measurements can be made. This method is also required for the preparation of practical heme-based blood substitutes. Preparation of such complexes has involved the "protected heme" approach, and examples are "capped

(5) (a) Chang, C. K.; Traylor, T. G. *Proc. Natl. Acad. Sci. U.S.A.* **1973**, *70*, 2647-2650. (b) Chang, C. K.; Traylor, T. G. *J. Am. Chem. Soc.* **1973**, *95*, 5810-5811. (c) Because chelated pyrrheme reversibly bound dioxygen in solution whereas mixtures of hemes and imidazoles had been reported to oxidize rapidly, we attributed some of the stabilization to the covalent attachment of the imidazoles. However, we<sup>6</sup> and others<sup>7,8</sup> soon found that our methods (low temperatures) could be used to prepare dioxygen complexes of a variety of heme-base mixtures. Nevertheless, the chelated heme method remains the best method of effectively maintaining five-coordination and has recently been adopted by many laboratories.

(6) Brinigar, W. S.; Chang, C. K.; Geibel, J.; Traylor, T. G. *J. Am. Chem. Soc.* **1974**, *96*, 5597-5599.

(7) (a) Anderson, D. L.; Weschler, C. J.; Basolo, F. *J. Am. Chem. Soc.* **1974**, *96*, 5599-5600. (b) Basolo, F.; Hoffman, B. M.; Ibers, J. A. *Acc. Chem. Res.* **1975**, *8*, 384-392.

(8) Wagner, G. C.; Kassner, R. J. *J. Am. Chem. Soc.* **1974**, *96*, 5593-5594.

(9) Almog, J.; Baldwin, J. E.; Dyer, R. L.; Peters, J. *J. Am. Chem. Soc.* **1975**, *97*, 226-227.

(10) (a) Collman, J. P.; Gagne, R. R.; Halbert, T. R.; Marchon, J. C.; Reed, C. A. *J. Am. Chem. Soc.* **1973**, *95*, 7868. (b) Collman, J. P.; Brauman, J. I.; Doxsee, K. M.; Halbert, T. R.; Suslick, K. S. *Proc. Natl. Acad. Sci. U.S.A.* **1978**, *75*, 564-566. (c) Collman, J. P. *Acc. Chem. Res.* **1977**, *10*, 265-272.

(11) Ogoshi, H.; Sugimoto, H.; Yoshida, Z. *Hukusokan Kogaku Torokai* **1975**, 239-243; *Chem. Abstr.* **1975**, *84*, 164069.

(12) Chang, C. K. *J. Am. Chem. Soc.* **1977**, *99*, 2819-2821.

(13) (a) Battersby, A. R.; Buckley, D. G.; Hartley, S. G.; Turnbull, M. D. *J. Chem. Soc., Chem. Commun.* **1976**, 879-881. (b) Battersby, A. R.; Hamilton, A. D. *Ibid.* **1980**, 117.

(14) Baldwin, J. E.; Huff, J. *J. Am. Chem. Soc.* **1973**, *95*, 5757-5758.

(15) (a) Chang, C. K.; Traylor, T. G. *Proc. Natl. Acad. Sci. U.S.A.* **1975**, *72*, 1166-1170. (b) Chang, C. K.; Traylor, T. G. *Biochem. Biophys. Res. Commun.* **1975**, *62*, 729-735.

(16) (a) Weschler, C. J.; Anderson, D. L.; Basolo, F. *J. Am. Chem. Soc.* **1975**, *97*, 6707-6713. (b) Tudge, J. R.; Ellis, P. E., Jr.; Jones, R. D.; Linard, I. E.; Szymanski, T.; Basolo, F.; Baldwin, J. E.; Dyer, R. H. *Ibid.* **1979**, *101*, 4762-4763 and references cited there.

hemes",<sup>9,16b</sup> "picket fence hemes",<sup>10</sup> "cyclophane hemes",<sup>4,13</sup> and "crowned hemes".<sup>12</sup> Such protection provides stability against reaction 2 but often alters the ligation properties of these hemes as compared to simpler models.<sup>15-17</sup>

In the dynamic model approach, fast reaction and fast spectroscopy methods are used to observe the reversible oxygenation even with those models which, by ordinary observation, instantaneously oxidize at room temperature. Examples are chelated hemes<sup>5,16a</sup> and heme-base mixtures.<sup>15b</sup> Models for this method, being unprotected, have the disadvantage of being rapidly oxidized at room temperature, even at low ( $\mu\text{M}$ ) concentration.<sup>6</sup> On the other hand, they can be easily prepared from the same hemes as those in native or reconstituted hemoprotein studies and, as it turns out, resemble the hemoproteins more closely than do the more elaborate protected models.<sup>18</sup> Considerable progress has been made by both methods with results which complement each other.<sup>19</sup>

Almost all of our work has involved the dynamic method. In this method the kinetic approach toward ligand reactions is part of the model design, and it is important to illustrate how reversible oxygenation is accomplished. First, we discovered that the dilute solutions of Im-Hm-CO complexes are, in most cases, very stable toward oxidation by dioxygen.<sup>15</sup> Therefore we were able to apply the commonly used<sup>1b</sup> flash photolysis and stopped-flow methods of hemoprotein oxygenation to our model compounds. Because dioxygen adds to hemes<sup>15</sup> and hemoproteins<sup>1b</sup> with association rate constants of  $>10^7 \text{ M}^{-1} \text{ s}^{-1}$  and dissociation rate constants of  $10$  to  $10^3 \text{ s}^{-1}$ , only a fraction of a second is needed to observe reversible oxygenation.<sup>20</sup>

In a typical flash photolysis study, devised first for hemoproteins by Gibson,<sup>21</sup> a mixture of 30 torr of dioxygen and 20 torr of CO is equilibrated with a solution of a heme model compound such as a chelated heme. This solution displays the UV-visible spectrum of the heme-CO complex. A short laser pulse removes the CO completely. The deoxy heme then reacts with dioxygen at a fast, but accurately measurable, rate ( $k_B^{\text{O}_2}$ ). Subsequently, in  $10^{-3}$  to  $10$  s, the heme-O<sub>2</sub> complex dissociates and returns to the heme-CO complex. The properties of the dioxygen complex can be measured by any of the fast ( $\sim 0.1$  s) methods. This process has been repeated as many as 200 times, i.e., 200 cycles of reversible oxygenation, at 20 °C without detectable oxidation of our model compound, chelated protoheme.<sup>18</sup>

Gibson<sup>21</sup> has shown that the return ( $k_{\text{return}}$ ) of the dioxygen complex to the CO complex is described by

$$\frac{1}{k_{\text{return}}} = \frac{1}{k_B^{\text{O}_2}} + \frac{K_B^{\text{O}_2}[\text{O}_2]}{k_B^{\text{CO}}[\text{CO}]} \quad (3)$$

where  $k_B^{\text{ligand}}$  and  $K_B^{\text{ligand}}$  refer to the association (+) and dissociation (-) rates and equilibrium constant for

(17) Traylor, T. G.; Campbell, D.; Tsuchiya, S. *J. Am. Chem. Soc.* **1979**, *101*, 4748-4749.

(18) Traylor, T. G.; Chang, C. K.; Geibel, J.; Berzins, A.; Mincey, T.; Cannon, J. *J. Am. Chem. Soc.* **1979**, *101*, 6718-6731.

(19) (a) For reviews of the important structural studies accomplished by the static method, see ref 7, 10, 16, 19b, and references cited there. (b) Jameson, G. B.; Molinaro, F. S.; Ibers, J. A.; Collman, J. P.; Brauman, J. I.; Rose, E.; Suslick, K. S. *J. Am. Chem. Soc.* **1980**, *102*, 3224-3237.

(20) In fact, reversible oxygenation of a simple heme-imidazole mixture can be observed in a stopped-flow apparatus at room temperature by the "oxygen pulse" technique.<sup>15b</sup>

(21) Gibson, Q. H. *Prog. Biophys., Biophys. Chem.* **1959**, *9*, 1-5.

Table I  
Comparison of Spectroscopic and Kinetic Properties of Hemoglobin and Chelated Protoheme<sup>a,b</sup>

| compound                                       | spectra <sup>c</sup> |            |            | rate constants <sup>d</sup>                                    |                               | equilibrium constants <sup>e</sup><br>M <sup>-1</sup>        |
|--|----------------------|------------|------------|--|-------------------------------|--|
|  | Soret                | $\alpha$   | $\beta$    | on M <sup>-1</sup> s <sup>-1</sup>                             | off s <sup>-1</sup>           |  |
| Hb   | 430 (133)            | 555 (12.5) |            |  |                               |  |
| chelated protoheme                             | 430 (114)            | 558 (13.5) |            |  |                               |  |
| Hb(CO) <sub>4</sub>                            | 419 (191)            | 569 (13.4) | 540 (13.4) | 6 × 10 <sup>6</sup>  | 0.006–<br>0.009               | 7 × 10 <sup>8</sup> –<br>1 × 10 <sup>9</sup>                 |
| chelated protoheme–CO                          | 420 (203)            | 569 (15.2) | 540 (16.3) | 3.6 × 10 <sup>6</sup><br>(4 × 10 <sup>6</sup> ) <sup>f</sup>   | 0.009<br>(0.007) <sup>f</sup> | 4 × 10 <sup>8</sup><br>(6 × 10 <sup>8</sup> ) <sup>f</sup>   |
| Hb(O <sub>2</sub> ) <sub>4</sub>               | 415 (125)            | 577 (14.6) | 541 (13.8) | 6 × 10 <sup>7</sup>  | 17 <sup>g</sup>               | 4 × 10 <sup>6</sup>  |
| chelated protoheme–O <sub>2</sub> <sup>h</sup> | 414 (121)            | 575 (14.2) | 543 (16.5) | 2.6 × 10 <sup>7</sup><br>(2.0 × 10 <sup>7</sup> ) <sup>f</sup> | 47<br>(44) <sup>f</sup>       | 5.5 × 10 <sup>5</sup><br>(5 × 10 <sup>5</sup> ) <sup>f</sup> |

<sup>a</sup> Chelated protoheme was suspended in 2% myristyltrimethylammonium bromide-phosphate buffer at pH 7.3 at 20 °C. <sup>b</sup> Since both hemoprotein and model kinetics were determined as functions of CO or O<sub>2</sub> pressures, the comparisons do not involve questions of solubilities in myristyltrimethylammonium bromide or protein solutions in this table or in Tables II or III. <sup>c</sup> Extinction coefficients, mM, in parentheses. Data for Hb from ref 1, p 19; for chelated protoheme from ref 18 and 23. <sup>d</sup> The oxygen rate constants are the average values for the  $\alpha$  and  $\beta$  chains. The chelated protoheme rates are from ref 18, 23 and 24. For Hb data, see: Antonini, E.; Gibson, Q. H. *Biochem. J.* 1960, 76, 534–538. DeYoung, A.; Pennelly, R. R.; Tan-Wilson, A. L.; Noble, R. W. *J. Biol. Chem.* 1976, 251, 6692–6698. Sharma, V. S.; Schmidt, M. R.; Ranney H. M. *Ibid.* 1976, 251, 4267–4272. Sawicki, C. A.; Gibson, Q. H. *Ibid.* 1977, 252, 7538–7547. <sup>e</sup>  $k_{\text{on}}/k_{\text{off}}$ . <sup>f</sup> In cetyltrimethylammonium bromide suspension. <sup>g</sup> Isolated Hb chains have  $k \cong 40$ , closer to that of chelated protoheme. See ref 1, p 352. <sup>h</sup> Static visible spectrum determined in 70:30 (v/v) DMF:H<sub>2</sub>O.

Table II  
Thermodynamic Parameters for the Reversible Reaction of Chelated Protoheme with O<sub>2</sub> and CO in Aqueous Myristyltrimethylammonium Bromide-Phosphate Buffer at pH 7.3<sup>a,b</sup>

| compound                         | $\Delta H^h$         | $\Delta S^h$     | $\Delta H^{\ddagger}_{\text{assoc}}^h$ | $\Delta S^{\ddagger}_{\text{assoc}}^h$ | $\Delta H^{\ddagger}_{\text{diss}}^h$ | $\Delta S^{\ddagger}_{\text{diss}}^h$ |
|----------------------------------|----------------------|------------------|--|--|---------------------------------------|---------------------------------------|
| chelated heme + CO               | -17.5                | -34              | 7.2                                    | -17                                    | 25                                    | 17                                    |
| chelated heme + O <sub>2</sub>   | -14                  | -35              | 7.2                                    | -13                                    | 21                                    | 21                                    |
| Hb(CO) <sub>4</sub>              | -17.4 <sup>c</sup>   | -34 <sup>c</sup> |  |  | 23.4 <sup>d</sup>                     |                                       |
| Hb(O <sub>2</sub> ) <sub>4</sub> | (-13.5–<br>-14.5)    |                  |  |  | 19.5 <sup>d</sup>                     |                                       |
| Hb chains + CO                   |                      |                  |  |  | 24 <sup>e</sup>                       |                                       |
| Hb chains + O <sub>2</sub>       | -13.5 <sup>c,f</sup> |                  |  |  | 21 <sup>e</sup>                       |                                       |
| Mb + O <sub>2</sub>              | -14 <sup>e,g</sup>   |                  |  |  |                                       |                                       |

<sup>a</sup> Hemoprotein data are included for comparison. <sup>b</sup> From ref 24. Kinetic and equilibrium data are in atm. <sup>c</sup> See: Gaud, H. T.; Barisas, B. G.; Gill, S. J. *Biochem. Biophys. Res. Commun.* 1974, 59, 1389–1394. Reference 1, p 244. <sup>d</sup> Reference 1, p 259. <sup>e</sup> Reference 1, p 221. <sup>f</sup> See: De Renzo, E.; Ioppolo, C.; Amiconi, G.; Antonini, E.; Wyman, J. *J. Biol. Chem.* 1967, 242, 4850–4854. <sup>g</sup> Reference 1, p 354. <sup>h</sup> kcal/mol.

ligation of a five-coordinated heme–base complex such as a chelated heme (see eq 4 and 5). Since  $k_{\text{B}}^{\text{CO}}[\text{CO}]$

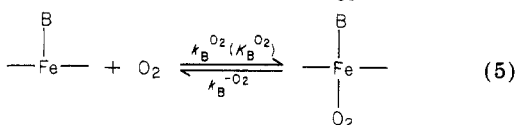
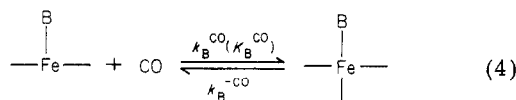

is the rate of return to the CO complex before O<sub>2</sub> is added, and thus is accurately determined in the same experiment, this kinetic study constitutes an O<sub>2</sub> titration for  $K_{\text{B}}^{\text{O}_2}$ . If [CO] is kept constant and O<sub>2</sub> varied, then a plot of  $1/k_{\text{return}}$  vs. O<sub>2</sub> (pressure) gives, as a slope,  $K_{\text{B}}^{\text{O}_2}/k_{\text{B}}^{\text{CO}}[\text{CO}]$ , and since  $k_{\text{B}}^{\text{CO}}[\text{CO}]$  is an experimentally determined quantity,  $K_{\text{B}}^{\text{O}_2}$  (pressure or concentration units) is obtained directly from a few flash photolysis experiments. In addition to  $K_{\text{B}}^{\text{O}_2}$ , this single series of experiments also affords a direct measure of  $k_{\text{B}}^{\text{O}_2}$  as well as two separate determinations of  $k_{\text{B}}^{-\text{O}_2}$  from either the intercept of eq 2 or  $k_{\text{B}}^{-\text{O}_2} = k_{\text{B}}^{\text{O}_2}/K_{\text{B}}^{\text{O}_2}$ . This provides an internal check of the method. These techniques were used to show that heme model compounds have affinities for O<sub>2</sub> which are similar to those of hemoglobin and myoglobin.<sup>15</sup> Subsequently this conclusion was confirmed by other methods using tet-

raphenylporphyrin-based model compounds.<sup>22</sup>

We also developed a new "CO-trap" method for measuring  $k_{\text{B}}^{-\text{CO}}$  and this,<sup>23</sup> with the  $k_{\text{B}}^{\text{CO}}$  described above, provides a measure of  $K_{\text{B}}^{\text{CO}}$ .<sup>24</sup> The only requirement which we have placed on model compounds is that they be five-coordinated, and we accomplished this by covalent attachment of a single imidazole (chelated hemes).<sup>5</sup>

The chelated heme which most resembles the active site of hemoglobins structurally is chelated protoheme (1) (Figure 1). This compound (like other unstrained chelated hemes) behaves spectroscopically and kinetically as a five-coordinated heme in all except acidic media.<sup>18</sup> It, like other chelated hemes, was characterized as its CO complex by NMR (see Figure 1). Some of the spectroscopic and dynamic properties of chelated protoheme are shown in Tables I and II. Not surprisingly, the spectroscopic properties of the deoxy, CO, and O<sub>2</sub> forms match those of hemoglobin. Both the <sup>13</sup>C chemical shift ( $\delta$  205.8) and the CO stretching frequency,  $\nu_{\text{CO}} = 1951$  cm in Me<sub>2</sub>SO, are almost iden-

(22) Collman, J. P.; Brauman, J. I.; Suslick, K. S. *J. Am. Chem. Soc.* 1975, 97, 7185–7186.

(23) (a) Sharma, V. S.; Ranney, H. M.; Geibel, J. F.; Traylor, T. G. *Biochem. Biophys. Res. Commun.* 1975, 66, 1301–1306. (b) Traylor, T. G.; Campbell, D.; Sharma, V.; Geibel, J. *J. Am. Chem. Soc.* 1979, 101, 5376–5383.

(24) Traylor, T. G.; Berzins, A. *Proc. Natl. Acad. Sci. U.S.A.* 1980, 77, 3171–3175.

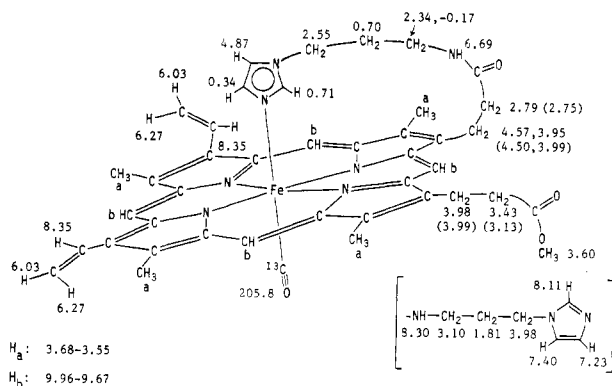

**Figure 1.** Chelated protoheme-CO. The numbers refer to the proton NMR positions of the CO complex in dimethyl sulfoxide. The numbers in parentheses are those for the chelated protoheme structure shown where they differ from dichelated protoheme (in which the OMe group is replaced by the side chain shown in brackets). These NMR data characterize chelated protoheme as having the indicated chelated structure in solution. Visible spectra of the NMR solution are identical with those of more dilute solutions used in kinetic and equilibrium studies.

tical with those of hemoglobin.<sup>25</sup>

Comparisons of the ligation properties with those of hemoproteins is made rather difficult by the wide variation in CO and O<sub>2</sub> affinity constants,  $K^{CO}$  and  $K^{O_2}$  of the hemoproteins. For example,  $K^{CO}$  varies from about zero for cytochrome *c* to almost  $10^9$  M<sup>-1</sup> for R-state hemoglobin. Molecular models and dynamic studies of chelated protoheme and related chelated hemes indicate that this structure is unstrained, and it therefore represents a standard structure for comparing protoheme-containing proteins. X-ray crystallography indicates the R state (fully ligated) of hemoglobin to be without appreciable strain. Having found that the kinetic,<sup>18,24</sup> equilibrium, and associated thermodynamic values<sup>24</sup> for CO and O<sub>2</sub> reactions with chelated hemes in aqueous CTAB suspension and with R-state hemoglobin in aqueous solution are very similar, we concluded that, in this and several other hemoproteins with similar affinities for CO, there are no special effects engendered by the protein to affect CO or O<sub>2</sub> affinities.<sup>26</sup> This conclusion was strengthened by the finding that microperoxidase, a natural chelated heme comprising an undecapeptide from cytochrome *c*, binds CO with  $K^{CO} = 10^9$  M<sup>-1</sup>  $P_{1/2}^{CO} = 0.0008$  torr) in water at pH 7<sup>24</sup> compared to 0.7 to  $1 \times 10^9$  M<sup>-1</sup> for hemoglobin R state (Table I).

### Structure-Reactivity

Many hemoproteins such as myoglobin, cytochrome P-450, peroxidases, and the T state of hemoglobin have lower affinities for CO or O<sub>2</sub> or both than does our standard model, hemoglobin chains or the equivalent, R-state hemoglobin. It was our objective to decide what factors in the protein bring about these changes. Some

(25) Model compounds of various structures in various solvents have  $\nu_{CO}$  which range from 1947 to 1983 cm<sup>-1</sup> (Table III), and therefore comparisons of this type do not mean very much.

(26) Collman, Brauman, and Doxsee<sup>27</sup> report half-pressures for CO binding to chelated picket fence heme of  $2 \times 10^{-5}$  torr in toluene and  $3 \times 10^{-6}$  torr in toluene-methanol compared to about  $4 \times 10^{-4}$  torr for our model compounds in both of these solvents. A decision as to which of these two model systems is a better standard for comparison must await detailed kinetic investigations of both. See ref 24 and 27 for discussions of this point.

(27) Collman, J. P.; Brauman, J. I.; Doxsee, K. M. *Proc. Natl. Acad. Sci. U.S.A.* 1979, 76, 4035-4039.

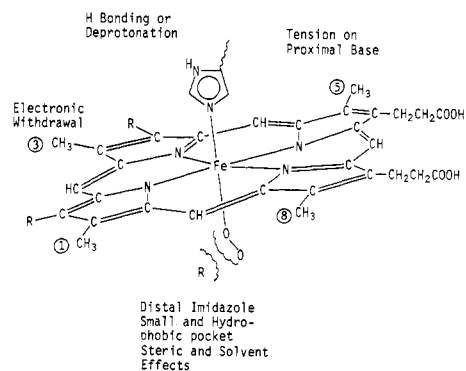

**Figure 2.** Proposed effects on O<sub>2</sub> and CO binding.

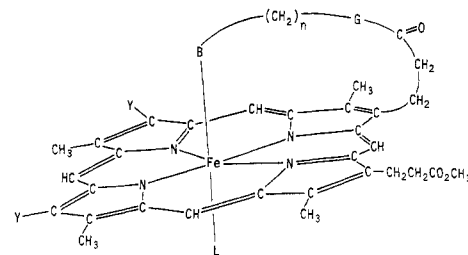

**Figure 3.** Chelated heme derivatives. See the text for definitions of B, *n*, Y, and G.

of the suggested effects are illustrated in Figure 2, and our studies of these effects are enumerated below.

**Proximal Base Tension.** The Hoard-Perutz<sup>28,29</sup> theory that pulling upon the imidazole-iron bond reduces the affinity for O<sub>2</sub> or CO in hemoglobin has been tested in model compounds in two different ways. We showed that chelated hemes having strain built into the chelation arm in any of three different ways ( $n = 2$ ,  $G = N$ -alkyl, or  $B = 1$ -(2-methylimidazolyl) in Figure 3) have increased O<sub>2</sub> dissociation rates, and thus lowered affinities.<sup>30</sup> In lowering  $n$  in Figure 3, we introduce a tilting of the proximal imidazole similar to that suggested by Baldwin<sup>31</sup> for T-state hemoglobin. Rougee and Brault<sup>32</sup> had found that the affinity of the hindered heme-2-methylimidazole for CO is 200 times less than that of heme-1-methylimidazole, which is very close to the difference between the R (high affinity) and T (low affinity) states of hemoglobin. Similar results for O<sub>2</sub> binding were reported by Collman, Brauman, et al.<sup>33</sup> We found that the kinetics of the CO binding to heme-1-methylimidazole and heme-2-methylimidazole in CTAB micelles approximately match those of R- and T-state hemoglobin<sup>34</sup> (see eq 6 and 7). Similar kinetic results were observed in benzene except that all rates were found to be somewhat faster than those in CTAB micelles. The numbers in parentheses are for hemoglobin R and T states, respectively,<sup>35</sup> and other numbers

(28) Hoard, J. L. In "Hemes and Hemoproteins"; Chance, B., Esterbrook, R. W., Yonetani, T., Eds.; Academic Press: New York, 1966; pp 9-10.

(29) Perutz, M. F.; Ten Eyck, L. F. *Cold Spring Harbor Symp. Quant. Biol.* 1971, 36, 295-298.

(30) Geibel, J.; Cannon, J.; Campbell, D.; Traylor, T. G. *J. Am. Chem. Soc.* 1978, 100, 3575-3585.

(31) Baldwin, J. M. *Prog. Biophys. Mol. Biol.* 1975, 29, 225-320.

(32) Rougee, M.; Brault, D. *Biochemistry* 1975, 14, 4100-4106.

(33) Collman, J. P.; Brauman, J. I.; Halbert, T. R.; Suslick, K. S. *Proc. Natl. Acad. Sci. U.S.A.* 1976, 73, 3333-3337.

(34) White, D. K.; Cannon, J. B.; Traylor, T. G. *J. Am. Chem. Soc.* 1979, 101, 2443-2454.

(35) Blough, N. V.; Zemel, H.; Hoffmann, B. M.; Lee, T. C. K.; Gibson, Q. H. *J. Am. Chem. Soc.* 1980, 102, 5683-5685.

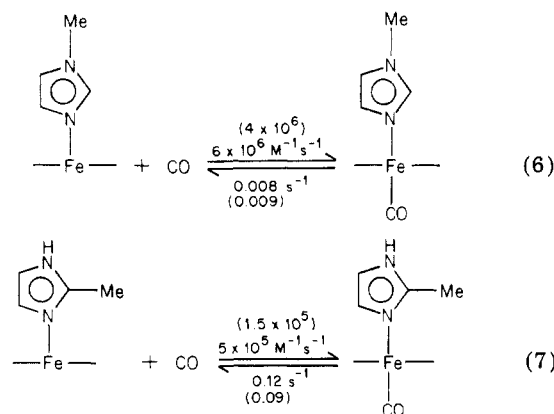

refer to mesoheme dimethyl ester in CTAB micellar suspension.

**Distal Side Steric Effects.** Pauling and his co-workers reported in 1951 that alkyl isocyanide affinities in hemoglobin and myoglobin decrease from  $\sim 10^5 \text{ M}^{-1}$  to  $\sim 10^3 \text{ M}^{-1}$  as the alkyl group increases in size from Et to *t*-Bu.<sup>36,37</sup> Chelated protoheme binds these isocyanides with affinities of  $(2-4) \times 10^8 \text{ M}^{-1}$  in benzene or aqueous suspension,<sup>38</sup> indicating steric reductions in hemoprotein affinities by factors of  $10^3$  to  $10^5$ . Some hemoproteins such as myoglobin and peroxidases have CO affinities which are reduced 10 to 200 times compared to hemoglobin chains or chelated hemes. These have also been attributed to steric effects.<sup>1c,27,30</sup> It has been suggested that hemoproteins in general have reduced CO affinities as a protection.<sup>27</sup>

We have modeled these steric effects with the cyclophane hemes 2, 3, and 4 in which the room for the entrance of a ligand in the distal pocket is progressively reduced<sup>17,39</sup> (see Figure 4). The CO and O<sub>2</sub> affinities of 2 are rather similar to those of chelated protoheme.<sup>40</sup> Both CO and O<sub>2</sub> affinities are reduced by about 700 in the more restricted cyclophane 3.<sup>39,40</sup> The 6,6-cyclophane, 3, has binding constants of  $5.5 \times 10^4 \text{ M}^{-1}$  for *n*-BuNC and  $1.5 \times 10^2$  for *t*-BuNC compared to  $(2-4) \times 10^8 \text{ M}^{-1}$  for chelated protoheme and  $5 \times 10^4$ ,  $8 \times 10^2$ , respectively, for myoglobin.<sup>1e</sup>

As in the case of the proteins, these reductions in affinity appear only in the association rates. This result, and the proximal base effect discussed above, provide a means of differentiating distal side steric effects from proximal side strain.<sup>38</sup> In the case of the proximal side strain in model studies described above, a reduction of CO affinity of 180 arose from a 12-fold decrease in association rate constants and a 15-fold increase in dissociation rate constants.<sup>34</sup> Thus proximal strain results in an approximately equal change in association and dissociation rates whereas distal side steric effects appear almost entirely in the association rate.

Applying this criteria to the reductions in CO affinity from R-state hemoglobin (or R-state models) to hemoglobin T state (300- to 600-fold) or myoglobin (15- to 20-fold),<sup>1d</sup> we reach different conclusions. The R- to T-state change in hemoglobin arises from a reduction

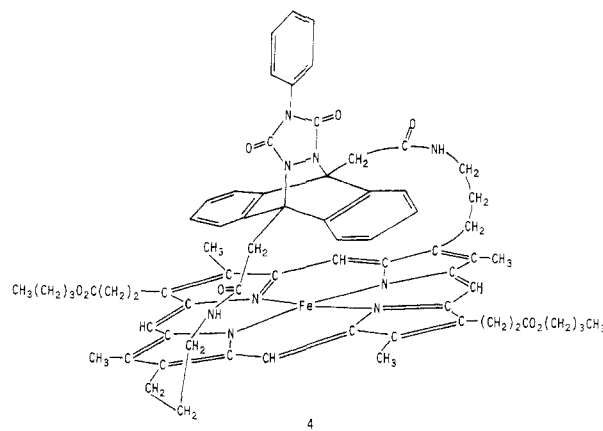
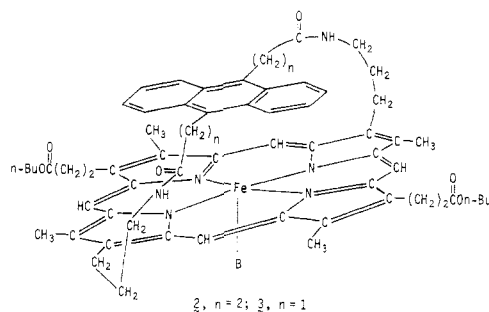

**Figure 4.** Cyclophane hemes (B = an imidazole in the affinity studies).

of 30- to 60-fold in the association rate and about 10-fold in the dissociation rate.<sup>35</sup> A similar conclusion can be reached concerning the isocyanide binding to R and T states of hemoglobin where the difference is approximately equally distributed between association and dissociation rates.<sup>37</sup> These two observations suggest predominantly a proximal side strain (Hoard-Perutz) for the R to T switch. The reduction in myoglobin affinity for CO is almost entirely in the association rate and is therefore attributed to steric effects.<sup>30</sup> Peroxidases show an even greater reduction in CO affinity, all of it in the association rate, suggesting that steric effects are also responsible for this reduction.

Our finding that distal side steric effects in model compounds appear entirely in the association rates suggests that these effects are caused by a rapid conformational preequilibrium between a closed, inaccessible conformation and an open state, followed by reaction of CO with the open state. Ligand molecules of different sizes and shapes would then encounter different ratios of accessible states, changing the size of this preequilibrium. Similar mechanisms are possible in hemoprotein reactions.<sup>41</sup> Such a mechanism and such kinetic results which suggest it are difficult to reconcile with any correlation of  $\nu_{\text{CO}}$ , Fe-CO angular distortion, etc., with the changes in CO affinities. In these cyclophane model systems CO and O<sub>2</sub> do not appear to be differentiated with regard to steric effects.<sup>39,40</sup>

**Side-Chain Electronic Effects.** The chelated hemes having Y = ethyl, vinyl, acetyl (Figure 2) and otherwise the same structure as chelated protoheme show rather similar CO kinetics and affinities but different CO stretching frequencies<sup>42-44</sup> (see Table III).

(36) St. George, R. C.; Pauling, L. *Science (Washington, D.C.)* **1951**, *114*, 626.

(37) Reisberg, P. I.; Olson, J. S. *J. Biol. Chem.* **1980**, *255*, 4159-4169.

(38) Traylor, T. G.; Stynes, D. V. *J. Am. Chem. Soc.* **1980**, *102*, 5938-5939.

(39) Traylor, T. G.; Campbell, D.; Tsuchiya, S.; Stynes, D. V. *J. Am. Chem. Soc.* **1980**, *102*, 5939-5941.

(40) Stynes, D. V.; Mitchell, M., unpublished.

(41) Case, D. A.; Karplus, M. *J. Mol. Biol.* **1979**, *132*, 343.

Table III  
Electronic Effects on CO and O<sub>2</sub> Affinities and CO  
Stretching Frequencies of Chelated Hemes<sup>a</sup>

| substituents<br>Y<br>(Figure<br>2) | K <sub>O<sub>2</sub></sub> , M <sup>-1</sup> | K <sub>CO</sub> , M <sup>-1</sup> | ν <sub>CO</sub> , <sup>b</sup> cm <sup>-1</sup> | k <sup>COc</sup> ,<br>M <sup>-1</sup> s <sup>-1</sup> |
|------------------------------------|--|-----------------------------------|---|---|
| ethyl                              | 1.3 × 10 <sup>6</sup>                        | 5.8 × 10 <sup>8</sup>             | 1946<br>(1964) <sup>d</sup>                     | 1.04 × 10 <sup>7</sup>                                |
| vinyl                              | 5.5 × 10 <sup>4</sup>                        | 7.2 × 10 <sup>8</sup>             | 1950  | 1.10 × 10 <sup>7</sup>                                |
| acetyl                             | 8.5 × 10 <sup>4</sup>                        | 7.0 × 10 <sup>8</sup>             | 1957  | 1.16 × 10 <sup>7</sup>                                |

<sup>a</sup> From ref 42 and 43. Equilibrium constants were determined in 2% myristyltrimethylammonium bromide suspension, IR stretching frequencies in dimethyl sulfoxide. Rate constants show somewhat more variation with structure than do equilibrium constants. <sup>b</sup> A similar trend of ν<sub>CO</sub> was observed by Alben and Caughey<sup>44</sup> for hemes in benzene. <sup>c</sup> Association rate constant in benzene. <sup>d</sup> In chloroform.

We conclude that CO binding is not very sensitive to electronic effects. However, the affinities for O<sub>2</sub> are sensitive to these changes. In aqueous suspension the K<sub>O<sub>2</sub></sub> (eq 5) for chelated hemes with Y = ethyl, vinyl, acetyl decreases from 1.3 × 10<sup>6</sup> M<sup>-1</sup> to 8.5 × 10<sup>4</sup> M<sup>-1</sup>, as shown in Table III. Similar effects have been reported for dioxygen binding to cobalt porphyrins<sup>45</sup> and hemoproteins.<sup>46</sup>

**Solvent Effects.** The equilibrium constants for CO binding to chelated protoheme are 6 × 10<sup>8</sup> M<sup>-1</sup> in aqueous micellar suspension and 4 × 10<sup>8</sup> M<sup>-1</sup> in benzene. With the higher solubility of CO in benzene, these data gave a P<sub>1/2</sub><sup>CO</sup> = 0.001 torr in water and 0.0004 torr in benzene.<sup>24</sup> The rate constant for CO dissociation is the same (0.03 s<sup>-1</sup>) in the very polar 50% H<sub>2</sub>O–50% MeOH solvent as it is in MeOH, 50% MeOH–50% toluene, and 95% toluene–5% MeOH, although slower (0.009 s<sup>-1</sup>) in CTAB micelles.<sup>23b</sup> The binding of CO to our model compounds seems to be rather insensitive to solvent polarity. By contrast the rate constant for dissociation of O<sub>2</sub> from chelated mesoheme–O<sub>2</sub> increases from 90 s<sup>-1</sup> to 1700 s<sup>-1</sup> in going from aqueous DMF to 90% toluene–10% methylene chloride,<sup>23</sup> corresponding to a decrease in O<sub>2</sub> affinity similar to that reported for cobalt porphyrins.<sup>47,48</sup>

**Proximal Base Effects.** The affinity of chelated hemes for CO (and the kinetics) are essentially identical for B = 1-imidazolyl or 3-pyridyl in Figure 3. However, this change to pyridine increases the O<sub>2</sub> dissociation rate and lowers the affinity for O<sub>2</sub> by a factor of about 20.<sup>15,18</sup> Taken with the effects of solvent polarity and electron donation discussed above, these results support the

(42) Traylor, T. G.; Berzinis, A.; White, D.; Campbell, D. *J. Am. Chem. Soc.*, submitted for publication.

(43) Traylor, T. G.; Berzinis, A.; Campbell, D.; Cannon, J.; Lee, W.; McKinnon, D.; Mincey, T.; White, D. K. In "Oxygen: Biochemical and Clinical Aspects"; Caughey, W. S., Ed.; Academic Press: New York, 1979; pp 455–476.

(44) Alben, J. O.; Caughey, W. S. *Biochemistry* 1968, 7, 175.

(45) Walker, F. A.; Berioz, D.; Kadish, K. M. *J. Am. Chem. Soc.* 1976, 98, 3484–3489.

(46) Seybert, D. W.; Moffatt, K.; Gibson, Q. H.; Chang, C. K. *J. Biol. Chem.* 1977, 252, 4225–4231.

(47) Styne, H. C.; Ibers, J. A. *J. Am. Chem. Soc.* 1972, 94, 5125.

(48) Collman et al.<sup>27</sup> report a tenfold increase in CO and O<sub>2</sub> affinities to picket fence heme when the solvent is changed from toluene to toluene–methanol 1:1. This result is (for CO) at variance with all of our CO affinity measurements. We find, in general, that the P<sub>1/2</sub><sup>CO</sup> decreases as the solubility of CO increases. However, the CO solubilities in MeOH and toluene are similar. Further studies of both systems will be required to resolve this rather striking discrepancy.

charge-separated formulation, Fe<sup>δ+</sup>–O–O<sup>δ-</sup>.<sup>11</sup>

**Proximal Base Deprotonation.** Whereas the change from imidazole to pyridine had little effect on CO affinities, the change from imidazole to imidazolide has a very large effect. We find that deprotonation of imidazole in the imidazole–protoheme complex decreases the affinity for CO by about 10<sup>2</sup>,<sup>49</sup> and a large decrease in the CO association rate has been reported.<sup>50</sup> The dominant effect seems to be a strong σ donation by the anion. The ν<sub>CO</sub> for the CO complex decreases from 1950 to 1935 cm<sup>-1</sup> (in Me<sub>2</sub>SO) upon this deprotonation.<sup>49</sup>

These anion–heme complexes, like the mercaptide complexes discussed later, are immediately oxidized when exposed to O<sub>2</sub> even at low temperature. The low oxidation potential, low CO affinities, and certain spectroscopic properties of these anion complexes resemble those of peroxidases and suggest that strong hydrogen bonding might be a key to the difference between the behavior of hemoglobin and peroxidases.<sup>43,50</sup>

**Rotation of the Proximal Base.** The Fe<sup>+</sup>–CN<sup>-</sup> derivatives of hemoglobin have the proton NMR positions of the 1-, 3-, 5-, and 8-methyl groups (see Figure 2) widely separated (over 18 ppm) whereas a simple imidazole–heme<sup>+</sup>–CN<sup>-</sup> has a separation of only 5 ppm.<sup>51</sup> This has been attributed to either heme edge contacts or rotation of the imidazole plane.<sup>52</sup> We have determined the NMR of chelated heme cyanides in which the imidazole rotational angle is changed and the rotational freedom reduced by changing from a free rotating external 1-methylimidazole base to a flexible chelated heme with a -(CH<sub>2</sub>)<sub>4</sub>-linkage (n = 4, G = NH, Y = vinyl, B = 1-imidazolyl in Figure 3 to a less flexible chelated heme with a -(CH<sub>2</sub>)<sub>3</sub>-linkage (n = 3).<sup>53</sup> The methyl group resonances change in this series from a spread of 5 ppm in the external base heme cyanide complex to 7 ppm in the n = 4 chelated protoheme to 17 ppm in the more rigid n = 3 chelated protoheme. The n = 3 chelated protoheme spectrum resembles that of hemoglobin<sup>+</sup>–CN<sup>-</sup>.

This indicates another way in which chelated protoheme mimics the behavior of hemoglobin and offers an explanation for the varying methyl chemical shifts of different low-spin ferric hemoproteins. The overlap of the imidazole π orbitals with the appropriate heme orbitals alters the hyperfine shifts of the two pyrrole groups within this overlap (i.e., methyls 1 and 5) more than it does the two pyrroles in the node of the imidazole π system (i.e., methyls 3 and 8). Incidentally, the compound shown in Figure 1 actually consists of a diastereomeric pair in which the two different side chains bind to iron. This mixed system (as the Fe<sup>+</sup>–CN<sup>-</sup> derivative) shows double resonances of each methyl group and thus provides a model for the recently discovered mixtures of hemoproteins in which the heme takes two orientations differing by 180°.<sup>54</sup>

(49) Mincey, T.; Traylor, T. G. *J. Am. Chem. Soc.* 1979, 101, 765–766.

(50) (a) Swartz, J. C.; Stanford, M. A.; Moy, J. N.; Hoffmann, B. M.; Valentine, J. S. *J. Am. Chem. Soc.* 1979, 101, 3396–3398. (b) Stanford, M. A.; Swartz, J. C.; Phillips, T. E.; Hoffmann, B. M. *Ibid.* 1980, 102, 4492–4499.

(51) Morishima, I.; Neya, S.; Inubushi, T.; Yonezawa, T.; Dizuka, T. *Biochim. Biophys. Acta* 1978, 534, 307–316.

(52) Walker, F. A.; La Mar, G. In "The Porphyrins"; Dolphin, D., Ed.; Academic Press: 1979; Vol. IV, pp 61–157.

(53) Traylor, T. G.; Berzinis, A. *J. Am. Chem. Soc.* 1980, 102, 2844–2846.

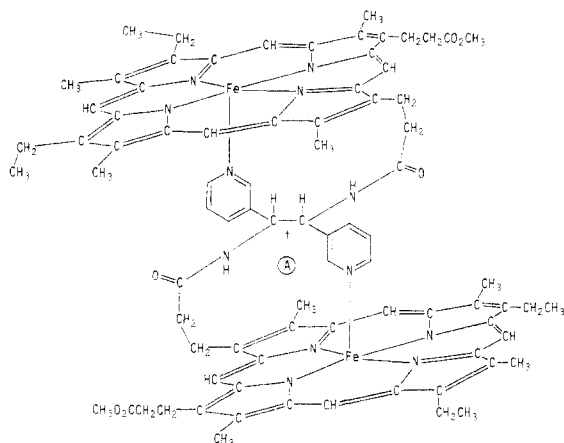

Figure 5. Pyridine chelated diHEME.

**Viscosity Effects and Cage Return.** Recent picosecond photolysis experiments,<sup>55</sup> rate vs. viscosity studies,<sup>56,57</sup> and theoretical calculations<sup>41</sup> have suggested that heme-CO photolysis results in some geminate recombination with hemoglobin (~50% recombination) and with hemes. Photolysis of CO complexes of model compounds such as chelated protoheme-CO or imidazole-tetraphenylporphyrin-CO<sup>50b</sup> display quantum yields of about 1.0 and show no evidence for cage return in ordinary solvents, even in mineral oil. The occurrence of cage return in hemoglobin suggests a very high effective viscosity (reduced CO diffusion) inside this protein. Studies of ligation of chelated protoheme at very high viscosities should establish the requirements for this reduced diffusion rate in proteins.

### Diheme Models for Hemoglobin

Cooperativity in hemoglobin is presumably accomplished through conformational changes which occur upon ligation of one of the hemes. As an example of conformational linkage between hemes, we prepared a centrosymmetric diHEME compound (5), Figure 5, in which the two hemes are in identical environments when ligated with, e.g., CO.<sup>58</sup> However, the chelation arm in each chelated heme is slightly strained, and we conjectured that conversion of the conformationally loose deoxy chelated heme to its rigid hexacoordinated form should rotate the common C-C bond and bring the second heme into a better position for binding.

Kinetics of reaction of this diHEME compound with CO reveal two rate constants, indicating either two environments or sequential change of environments. This discovery of conformationally linked heme functions in model systems promises to reveal something of the nature of allosteric interaction and is under further study.

### Mechanisms of CO Association

The rate constants for the reaction of CO with four-coordinated mesoheme in CTAB or in benzene is

(54) La Mar, G. N.; Budd, D. L.; Smith, K. M.; Langry, K. C. *Proc. Natl. Acad. Sci. U.S.A.* **1978**, *75*, 5755-5759.

(55) Duddell, D. A.; Morris, R. J.; Richards, J. T. *Biochim. Biophys. Acta* **1980**, *621*, 1-8.

(56) (a) Caldin, E. F.; Hasinoff, B. B. *J. Chem. Soc., Faraday Trans. 1* **1975**, *71*, 515-527. (b) Hasinoff, B. B. *Arch. Biochem. Biophys.* **1977**, *183*, 176-188.

(57) Beece, D.; Eisenstein, L.; Frauenfelder, H.; Good, D.; Marden, M. C.; Reinisch, L.; Reynolds, A. H.; Sorenson, L. B.; Yue, K. T. *Airlie House Symp.*, April, 1980, in press.

(58) Traylor, T. G.; Tatsuno, Y.; Powell, D. W.; Cannon, J. B. *J. Chem. Soc., Chem. Commun.* **1977**, 732-734.

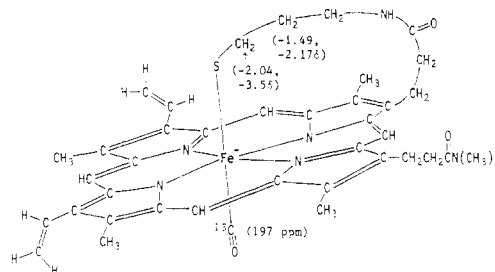
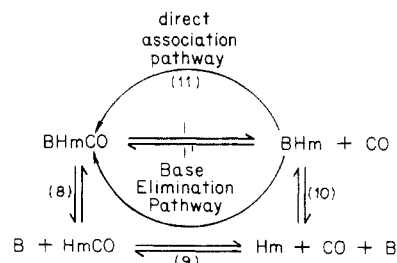

Figure 6. Mercaptide chelated heme.

$3 \times 10^8 \text{ M}^{-1} \text{ s}^{-1}$  compared to  $1 \times 10^7 \text{ M}^{-1} \text{ s}^{-1}$  for chelated mesoheme.<sup>59</sup> This faster reaction of four-coordinated heme and the increased binding constant for imidazoles upon addition of carbon monoxide result in a change of mechanism when the pH is lowered or the proximal base is strained. These structural changes result in a more rapid dissociation of imidazole, resulting in the base-elimination pathway<sup>30,34,59</sup> (eq 8-11).



Although chelated protoheme and other unstrained chelated hemes react by the direct association mechanism (eq 11) in organic solvents or in aqueous medium above pH 6, the strained hemes ( $n = 2$  or  $B = 1$ -(2-methylimidazolyl)- or  $G = N$ -alkyl in Figure 2) or sterically hindered cyclophane hemes such as 3 react through base elimination.<sup>30,59,60</sup> External base heme mixtures react with CO by base elimination except at very high concentration of imidazoles.<sup>34</sup> This mechanism change has been suggested for myoglobin-CO reactions at low pH<sup>61</sup> and for the reaction of hemoglobin with NO under some conditions.<sup>62</sup> It is also possible that the fast CO reactions with chironomus hemoglobin or hemoglobin Zürich could be due to such a mechanism change.

### Mechanisms of Heme Oxidation

The rates of oxidation of heme-bis(pyridine) by dioxygen was reported by Cohen and Caughey<sup>63</sup> to be second order in heme and inversely dependent upon pyridine. The mechanism which they proposed (eq 12 and 13) has been further documented by our study of

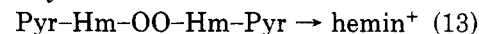
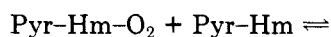
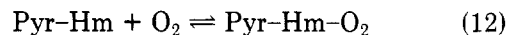

the oxidation of a chelated heme under  $\text{O}_2$  binding conditions. We find this reaction to be second order

(59) (a) Cannon, J.; Geibel, J.; Whipple, M.; Traylor, T. G. *J. Am. Chem. Soc.* **1976**, *98*, 3395-3396. (b) Geibel, J.; Chang, C. K.; Traylor, T. G. *Ibid.* **1975**, *97*, 5924-5926.

(60) Traylor, T. G.; Berzinis, A. P.; Cannon, J. B.; Campbell, D. H.; Geibel, J. F.; Mincey, T.; Tsuchiya, S.; White, D. K. *Adv. Chem. Ser.* **1980**, *No. 191*, 219-233.

(61) Giacometti, G. M.; Traylor, T. G.; Ascenzi, P.; Brunori, M.; Antonini, E. *J. Biol. Chem.* **1977**, *252*, 7447-7448.

(62) Szabo, M.; Perutz, M. *Biochemistry* **1976**, *15*, 4427-4428.

(63) Cohen, F. A.; Caughey, W. S. *Biochemistry* **1968**, *7*, 636-640.

in heme and inversely proportional to oxygen concentration as required by eq 13 when Hm-O<sub>2</sub> is the dominant species.<sup>64</sup> Spectroscopic evidence for the Fe-O-O-Fe species was recently reported by La Mar et al.<sup>65</sup>

### Mercaptide Chelated Heme

Although mixtures of mercaptide ion with hemes<sup>66-68</sup> mimic many of the properties of cytochrome P-450 and give evidence for the RS-Fe structure in this enzyme, there remains the possibility of the excess RS<sup>-</sup> interfering with the dynamic behavior of the P-450 model system. We have prepared a chelated heme having an internally bound mercaptide<sup>69</sup> (Figure 6) which shows strikingly similar behavior, in aqueous micelles, to that of cytochrome P-450. The low CO affinity of this model compound is in agreement with the anion data presented above and with the mercaptide heme-CO kinetic data of Chang and Dolphin.<sup>68b</sup>

We have also discovered diagnostic NMR resonances in this model compound which afford definitive probes in the enzyme.<sup>70</sup> (See Figure 6.) Both the <sup>13</sup>CO NMR

(64) Chang, C. K.; Powell, D.; Traylor, T. G. *Croat. Chem. Acta* 1977, 49, 295-307.

(65) Chin, D.; Del Gaudio, J.; La Mar, G. N.; Balch, A. L. *J. Am. Chem. Soc.* 1977, 99, 4487-4488.

(66) (a) Stern, J. O.; Peisach, J. *J. Biol. Chem.* 1974, 249, 7495-7496. (b) Stern, J. O.; Peisach, J. *FEBS Lett.* 1976, 62, 364-365.

(67) Collman, J. P.; Sorell, T. N.; Dawson, J. H.; Trudell, J. R.; Bunnenberg, E.; Djerassi, C. *Proc. Natl. Acad. Sci. U.S.A.* 1976, 73, 6-10.

(68) (a) Chang, C. K.; Dolphin, D. *J. Am. Chem. Soc.* 1975, 97, 5948-5949. (b) Chang, C. K.; Dolphin, D. *Proc. Natl. Acad. Sci. U.S.A.* 1976, 73, 3338-3340.

(69) (a) Traylor, T. G.; Mincey, T. *Acta Biol. Med. Germ.* 1979, 38, 351-355. (b) T. Mincey, Thesis, UCSD, 1979.

(70) Berzinis, A. P.; Traylor, T. G. *Biochem. Biophys. Res. Commun.* 1979, 87, 229-235.

and the NMR of the protons  $\alpha$  and  $\beta$  to the -S-Fe are definitive for this structure. The model RS-Fe-<sup>13</sup>CO is the only such system (including Im<sup>-</sup>-Fe-CO) in which the chemical shift for <sup>13</sup>CO is less than 200 ppm. In P-450<sub>cam</sub> this resonance is at 200 ppm, compared to 197 ppm in the model. The  $\alpha$ - and  $\beta$ -CH<sub>2</sub> proton resonances, being at higher field than Me<sub>4</sub>Si, should be clearly visible in the protein. The <sup>13</sup>C and proton NMR of various P-450 enzymes, their P-420 forms, and chloroperoxidase should reveal a great deal about the structure around the heme.

### Conclusions

Model compounds have been designed to probe structure-reactivity relationships in the ligation of hemes with O<sub>2</sub>, CO, and isonitriles. The heme affinity for dioxygen was shown to be sensitive to electronic effects, proximal basicity, and solvent polarity, none of which greatly affect CO affinities. Both CO and O<sub>2</sub> affinities are lowered by proximal base tension. Distal side steric effects in model compounds approximating those in myoglobin have been achieved, and a kinetic method for distinguishing distal from proximal side effects has been discovered.

*This work was performed at UCSD with support from the National Institutes of Health (Grant HL-13581) and the National Science Foundation (Grant CHE 78-50003). The NMR facilities used in this study are supported by the National Institutes of Health (Grant RR-708). I am grateful to my co-workers, Drs. H. Diekmann, Y. Ito, C. K. Chang, J. Cannon, J. Geibel, D. White, T. Mincey, A. Berzinis, D. Campbell, S. Tsuchiya, Y. Tatsuno, D. V. Stynes, D. Powell, and M. Mitchell, whose work is reported here.*

## Metalla- $\beta$ -diketones and Their Derivatives

CHARLES M. LUKEHART

Department of Chemistry, Vanderbilt University, Nashville, Tennessee 37235

Received September 22, 1980

$\beta$ -Diketones are versatile reagents in both inorganic and organic chemistry. Coordination of the enolate anions of  $\beta$ -diketones to metal ions affords a large class of thermally stable metal complexes. Complexes of macrocyclic ligands can be prepared by reacting  $\beta$ -diketones with metal amine complexes via template synthesis.  $\beta$ -Diketones also condense with trigonal boron molecules and other nonmetallic compounds to give coordination complexes of these representative elements. In most of these complexes, a  $\beta$ -diketonate anion acts as a bidentate, chelating ligand.

Condensation reactions of  $\beta$ -diketones or  $\beta$ -keto esters provide a convenient synthetic route to several different classes of molecules. For example, condensation with amines affords  $\beta$ -keto imines, while condensation with

hydrazines gives pyrazole derivatives. Ureas and amidines afford pyrimidine condensation products, including uracil derivatives, and pyridine ring systems are formed by condensation of  $\beta$ -diketones with cyanacetamide. Self-condensation of poly- $\beta$ -keto anions affords aromatic molecules, e.g., resorcinol, orcinol, or orsellinic acid.

Recently, a class of organometallic complexes has been prepared in which the methine group of either a  $\beta$ -diketonate anion or the enol tautomer of a neutral  $\beta$ -diketone has been substituted by a transition-metal organometallic moiety. These transition metal fragments are isovalent to a methine group, and such complexes are referred to as metalla- $\beta$ -diketones because the metal moieties are directly incorporated into the  $\sigma$ - and  $\pi$ -bonding network of the  $\beta$ -diketonate functionality. When using these metalla- $\beta$ -diketones as reagents, it is possible to prepare metalla analogues of many of the compounds prepared via  $\beta$ -diketone chemistry. These new classes of compounds include the metalla-

Charles M. Lukehart is Associate Professor of Chemistry at Vanderbilt University. He attended The Pennsylvania State University (BS., 1968) and Massachusetts Institute of Technology (Ph.D., 1972) and spent 1 year of postdoctoral study at Texas A&M University. He joined the Vanderbilt faculty in 1973 and is currently an Alfred P. Sloan Research Fellow.